

Article number: 20511M525
Description: E+G Clamping kit
GN 511-M5-25

Measures

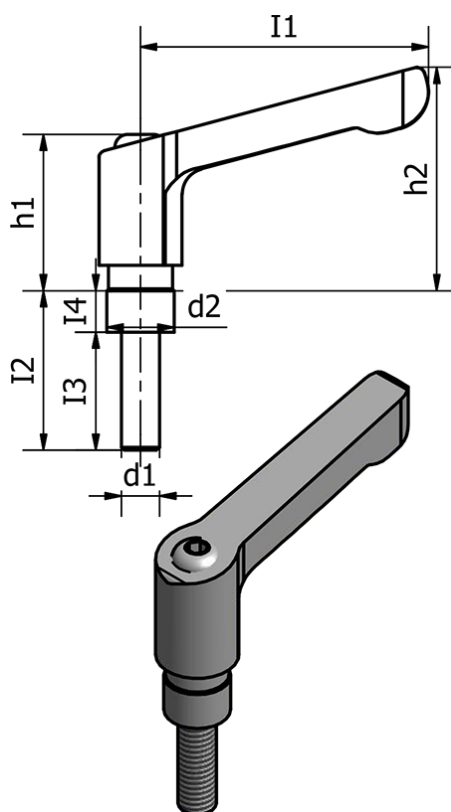

d1 = 5

d2 = 9

h1 = 24.5

h2 = 30

I1 = 30

I2 = 25

I3 = 19

I4 = 6

Weight (g) = 40